

## PESC20120YCT

### 20.0AMPS.SIC SCHOTTKY BARRIER DIODE

**FEATURE**

- . 1200V Schottky Diode
- . Zero Reverse Recovery/Zero Forward Recovery
- . High Efficiency Operation
- . Extremely Fast Switching
- . Temperature Independent Switching Behavior

**TYPICAL APPLICATIONS**

- . Switch mode power supply
- . Power factor correction Solar Invertor
- . Solar inverter
- . Uninterruptible power supply

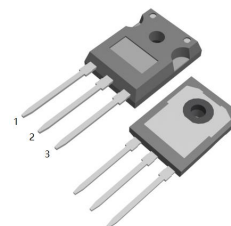

TO-247-3L

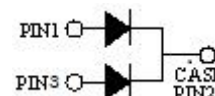
**MAXIMUM RATINGS** ( $T_C=25^\circ\text{C}$  unless otherwise noted)

Parameter	Symbol	PESC20120YCT	Units
Maximum Recurrent Peak Reverse Voltage	$V_{RRM}$	1200	V
Maximum DC blocking Voltage	$V_{DC}$	1200	V
Maximum Average Forward Rectified Current <i>Per Leg</i> at $T_C=150^\circ\text{C}$ <i>Total device</i>	$I_{F(AV)}$	10 20	A
Non-Repetitive Peak Forward Surge Current $T_C=25^\circ\text{C}$ , $t_p=8.3$ ms, Half Sine Pulse <i>Per Leg</i>	$I_{FSM}$	95	A
Total power dissipation $T_C=25^\circ\text{C}$	$P_D$	176	W
Operation Junction Temperature and Storage Temperature	$T_J, T_{STG}$	-55 to +175	$^\circ\text{C}$

**ELECTRICAL CHARACTERISTICS**-(per leg) ( $T_C=25^\circ\text{C}$  unless otherwise noted)

Parameter	Symbol	Typ	Max	Units	
Forward voltage	$V_F$	$I_F=10\text{A}, T_j=25^\circ\text{C}$	1.45	1.8	V
		$I_F=10\text{A}, T_j=175^\circ\text{C}$	2.0	2.3	
Reverse current	$I_R$	$V_R=1200\text{V}, T_j=25^\circ\text{C}$	8	100	$\mu\text{A}$
		$V_R=1200\text{V}, T_j=175^\circ\text{C}$	40	500	
Total capacitive charge	$Q_c$	41	---	nC	
Total capacitance	$C$	$V_R=0.1\text{V}, T_j=25^\circ\text{C}, f=1\text{MHZ}$	700	---	pF
		$V_R=400\text{V}, T_j=25^\circ\text{C}, f=1\text{MHZ}$	49	---	
		$V_R=800\text{V}, T_j=25^\circ\text{C}, f=1\text{MHZ}$	41	---	

**THERMAL CHARACTERISTICS**( $T_C=25^\circ\text{C}$  unless otherwise noted)

Parameter	Symbol	Typ	Max	Units
Typical Thermal Resistance Junction to Case	$R_{(JC)}$	0.85	----	$^\circ\text{C}/\text{W}$

RATING AND CHARACTERISTIC CURVES

FIG.1-FORWARD CHARACTERISTICS

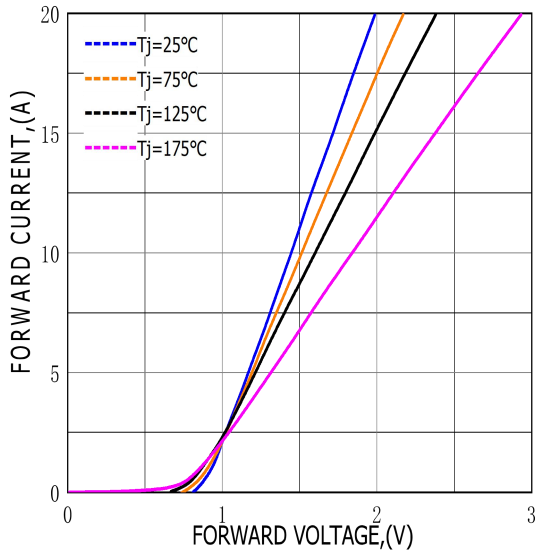

FIG.2-REVERSE CHARACTERISTICS

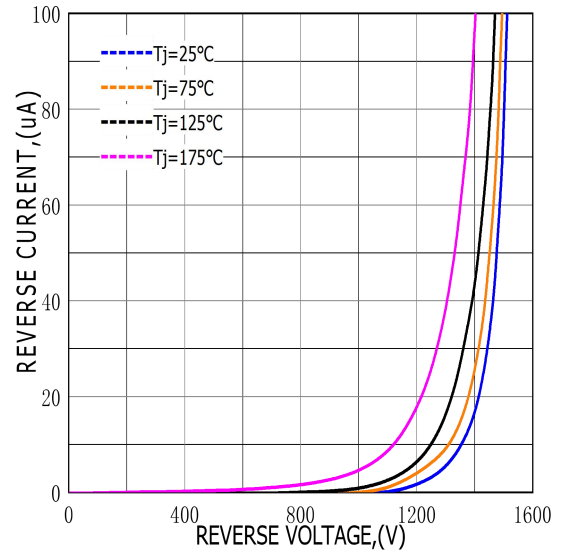

FIG.3-TOTAL CAPACITANCE CHARGE VS REVERSE VOLTAGE

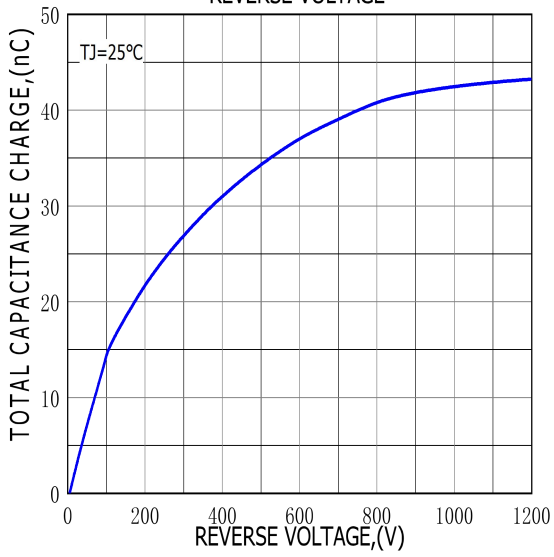
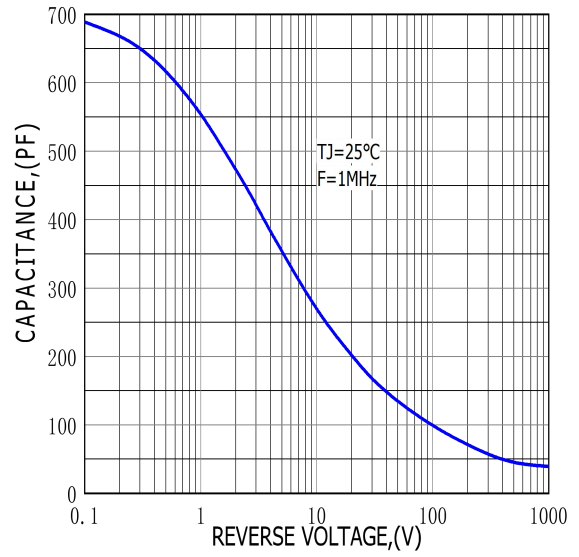
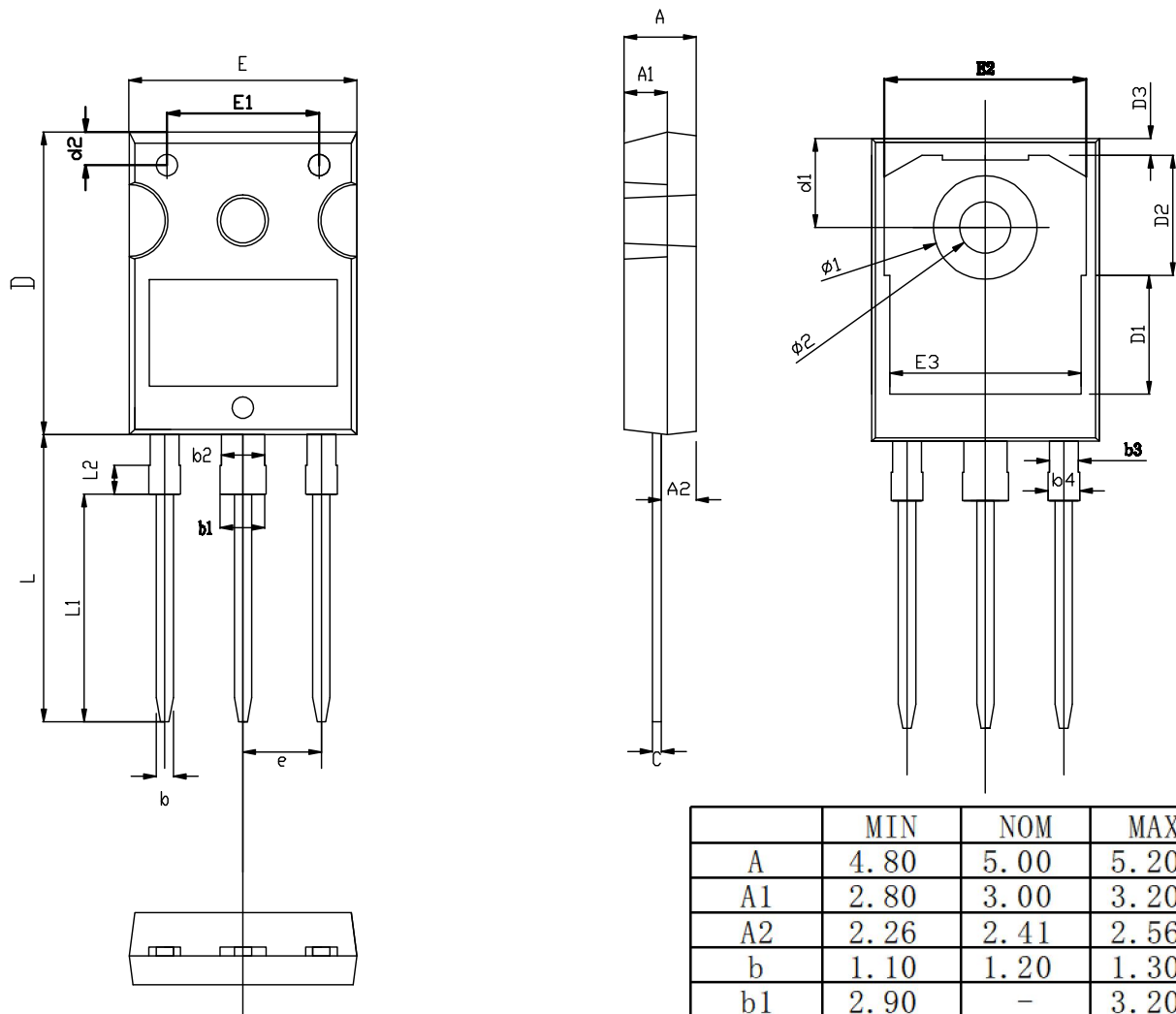

FIG.4-CAPACITANCE VS REVERSE VOLTAGE



# TO-247-3L PACKAGE OUTLINE



RECOMMENDED LAND PATTERN

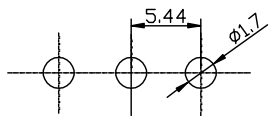

UNIT: mm

	MIN	NOM	MAX
A	4.80	5.00	5.20
A1	2.80	3.00	3.20
A2	2.26	2.41	2.56
b	1.10	1.20	1.30
b1	2.90	-	3.20
b2	2.90	3.00	3.10
b3	1.90	2.00	2.10
b4	2.00	-	2.20
c	0.50	0.60	0.70
D	20.80	21.00	21.20
D1		8.23	
D2		8.32	
D3		1.17	
d1	6.00	6.15	6.30
d2	2.20	2.30	2.40
E	15.60	15.80	16.00
E1		10.50	
E2		14.02	
E3		13.50	
e	5.34	5.44	5.54
L	19.72	19.92	20.12
L1		15.79	
L2		1.98	
ø1	7.10	7.19	7.30
ø2	3.50	3.60	3.70